



**aluglass**<sup>®</sup>

**bautech**

ISO 9001  
certified by



# MODULAR SCREEN SYSTEM

*FOR SCHOOLS OR ANY OTHER  
SHARED DESKS APPLICATION!*



**SQUARE DESKS | RECTANGULAR DESKS | ROUND DESKS**



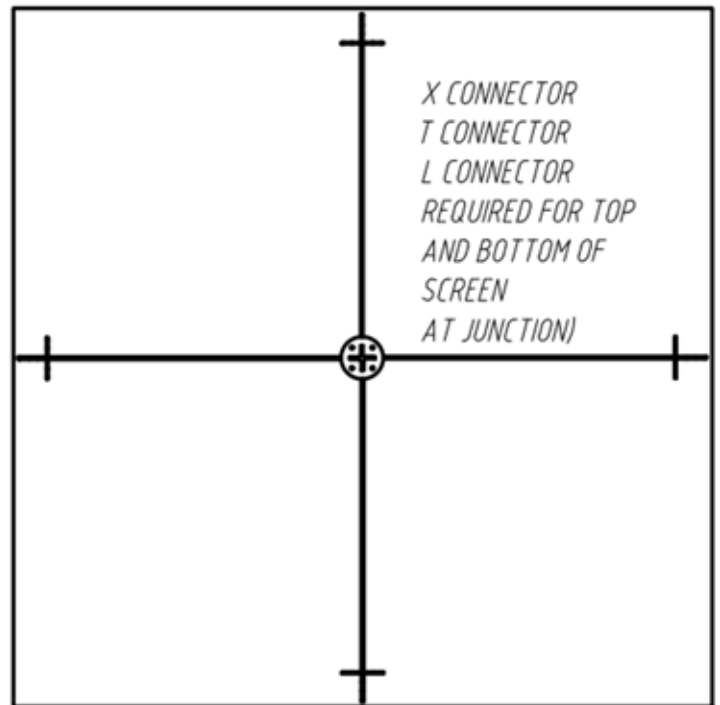
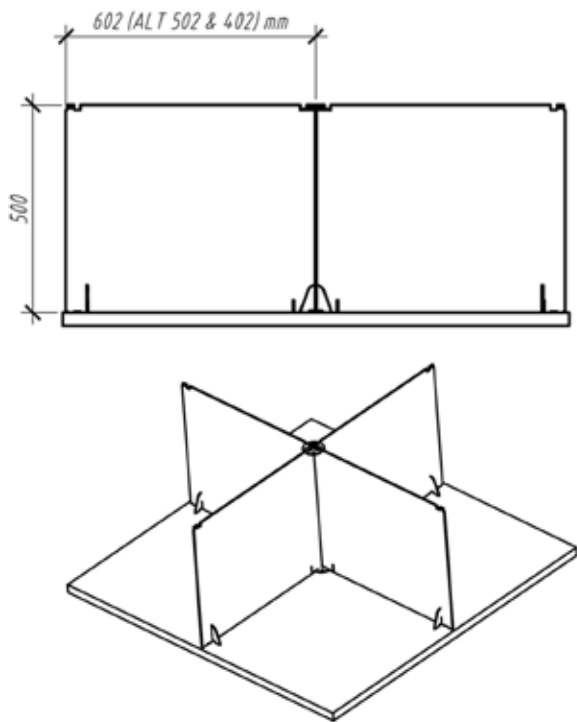

## Modular configurations available

Standard single screens and L, T or X configurations

### Screen dimension options:

402mm wide x 500mm high  
 502mm wide x 500mm high  
 602mm wide x 500mm high



Visit [www.aluglass.co.za](http://www.aluglass.co.za) for more information!

Tel: 011 451 8400

E-mail: [svenja@aluglass.co.za](mailto:svenja@aluglass.co.za)

## Simple desk set-up examples

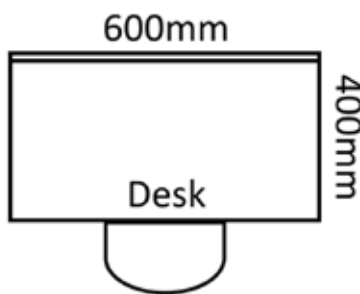

*single desk front screen*

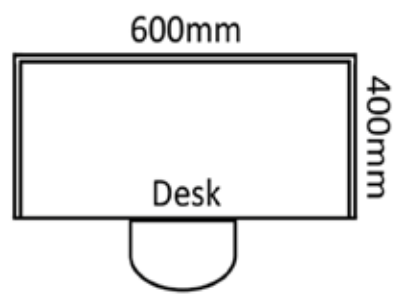

*single desk front & sides screens 'box format'*

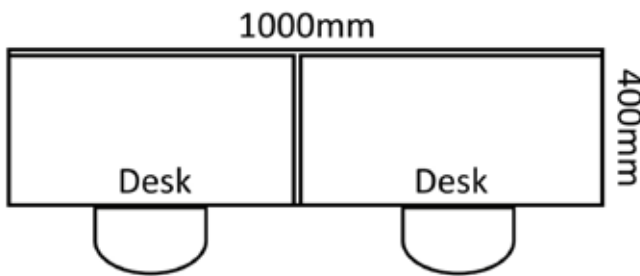

*double desk front screens and separator screen*

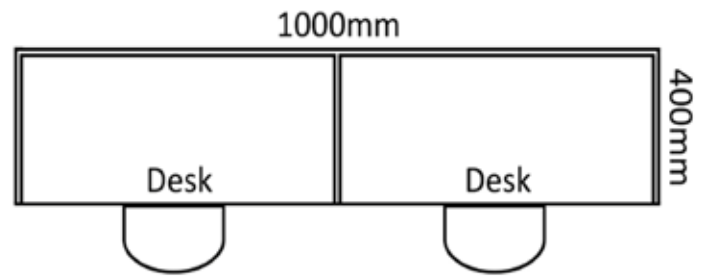

*double desk front & sides screens 'box format'*

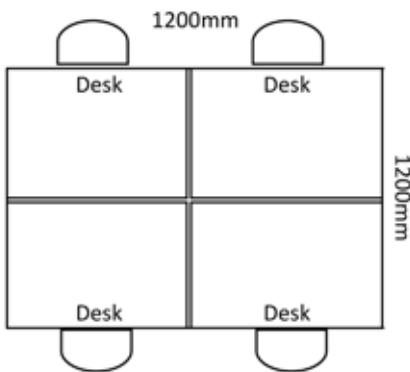

*rectangular 4seater desk  
with X-configuration*

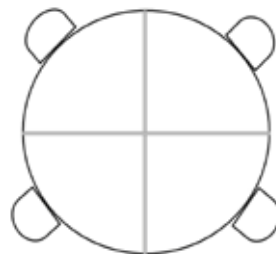

*round 4-seater desk  
with X-configuration*

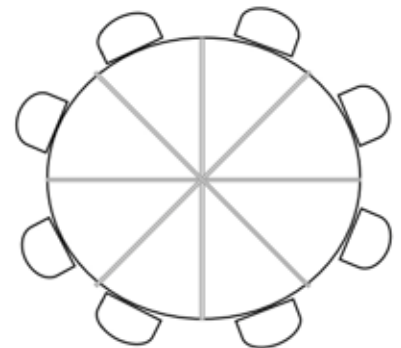

*round 8-seater desk  
with 2 x X-configuration*

Applications include:  
call centres, open plan offices, school desks, production facilities...





**aluglass**®

**bautech**

ISO 9001  
certified by



## Installation Instruction:

The VIRUS SCREEN comes with a high bond double sided adhesive tape on the underside of the plexi base. Use your isopropanol disinfectant spray or fluid to remove fat residue from the surface the base needs to adhere to. Use a paper towel to dry, pull tap tabs off and place screen firmly on substrate. Apply pressure to areas where tape is.

Tape adhesive cures for approx. 12 hrs until full bond strength is achieved. Alternatively, the screens can be screwed onto the desks for added stability.

## Cleaning Instructions:

To clean plexiglass that has slight blemishes or dirt, start off by clearing away any debris. Then, use a premium micro-fibre cloth with soapy water to clean the entire surface area.

After wetting the cloth, be sure to lightly blot the surface, rather than applying pressure as you wipe. Too much pressure can actually cause scratches. After you have wiped the entire piece of acrylic, use the dry side of the cloth to dry or buff the area. Buffing or polishing the acrylic surface reduces future stains. If there are any remaining streaks, wet the cloth and dry again.

**Choose Carefully:** There are a couple of cleaning items that you'll want to stay away from. In fact, using the wrong cleaning product can completely damage your acrylic displays to the point that they become unusable!

**Do not** use paper towels, because they will not remove scratches, but may even cause them. Stick with micro-fibre type of cloth. Avoid ammonia based products, like Windex or other home glass cleaners, because they contain harmful chemicals that will actually damage the surface leaving it cloudy looking. Soapy water is the safest and most effective cleaning solution for acrylic.